

ProOrbit[®] v3

The perfect software for Bore alignment

Software Manual

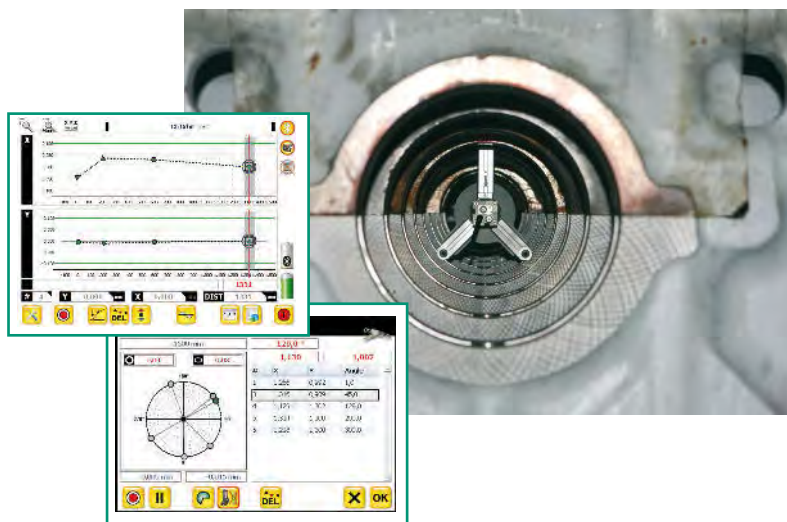

Software Manual – English

ProOrbit®v3

Please note: Software Manuals can be amended when improvements or changes to the product range have been carried out. Use the link to make sure you have the most up to date version of your Manual: www.statuspro.com/machine_geometry/documents/.

Content

1. LIABILITY EXCLUSION	3
2. PROGRAMME START	3
2.1 Laser setup	4
3. COORDINATE SYSTEM	5
3.1 Choosing a coordinate system	5
4. MEASUREMENT PROCEDURE	6
4.1 Setup and measurement	6
4.2 LED on the R545	6
4.3 Charging of the R545	6
4.4 Programme outlay	7
4.5 The measurement screen	8
4.6 Measurement methods	9
4.6.1 The two point measurement	9
4.6.2 The „4-Point“ Measurement	10
4.6.3 The Multipoint Measurement	10
4.6.4 Measurements without the built-in inclinometer	11
4.7 Analysis	13
4.7.1. Zero points	14
4.7.2. Raw data	14
4.7.3. „Best fit“ Line	15
5. THE RAW DATA SCREEN	16
6. THE INITIAL SETUP SCREEN	17
6.1 Setup bar	18

6.2 Save to memory/measurement name 18
 6.3 Open an existing measurement 19
7. NEW SENSORS / LICENSE KEY 19

1. Liability Exclusion

The Status Pro GmbH does not accept responsibility for damage incurred through incorrect use or handling of the equipment. To ensure correct usage, a founded knowledge of the equipment is essential. It is of the utmost importance that you read and understand the manual. No responsibility will be accepted for damage incurred through ignorance or disregarding of the operating instructions.

2. Programme Start

Start the software by pressing the appropriate desktop symbol. The first picture after the start up screen is the following:



Press the symbol to receive raw data from the sensor. This Information helps you to align the sensor to the laser.



Here you will see information concerning the angle of the detector, the X and Y coordinates. By pressing Zero at the start, then rotating the sensor through 180° and finally halving the value at 180°, you receive the position of the laser beam in respect to the centre of the bore – enabling adjustment accordingly.

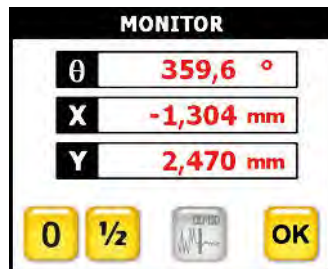

2.1 Laser setup

Position the laser roughly by tape measure in the middle of the bore (+ -2mm). Position the tape measure in the first bore and move the laser parallel until it fits in the middle.

Position the laser in the first bore using the appropriate brackets, then adjust the Laser in side and height to within 2mm of the first bore centre using a tape measure. Then adjust the angle (1 screw per axis) of the laser beam to the centre of the last bore, again using a tape measure in the last bore.

Mount the sensor using the appropriate bracket roughly in the centre of the first bore as near to the laser as possible, positioning the spring loaded ball at "12 o'clock". Open the target screen, then zero the values on the UMPC. Turn the sensor through 180 degrees then halve the values. Adjust the parallel offset of the laser beam to zero in side and height (2 screws per axis). Mount the sensor in the last bore positioning the springloaded ball at 12 o'clock, zero the values then rotate the sensor through 180 degrees. Halve the values, then adjust the angle of the laser beam to zero in side and height (1 screw per axis). Check the values at the first bore again and repeat first and last bore adjustments if necessary.

Disable the "zero" function in the monitor display. Now the offset of the aligned laser beam towards the receiver is displayed. If needed the receiver bracket can be adjusted until the value is ≥ 1 mm.



Caution!

An absolute stable mounting of the laser source is needed in order to receive good results!

3. Coordinate System

You can choose the coordinate system in the Menu according to your setup. The most common set up is that the laser is positioned to your left side and you start with the measurement sensor near the laser (0). Now you move the receiver from bore to bore, from left to right. All values in Y (height) reading positive, are above the ideal line. All values in X (side) that are positive, are away from you. The graphics show the deviations as they appear.

X – Coordinate: Deviation in the horizontal plane
 – X the receiver is closer to the operator
 + X the receiver is further away from the operator

Y – Coordinate: Deviation in the vertical plane.
 + Y The receiver is too high
 – Y The receiver is too low.

Graphic:

The Graphic shows the deviation from the ideal line. By positioning the screen in front of the machine you can see the deviation as it really is. Look at the screen by holding the screen upright and you will see the deviation in the height as it is. Hold the screen horizontally and you will see the deviation in the side as it is.

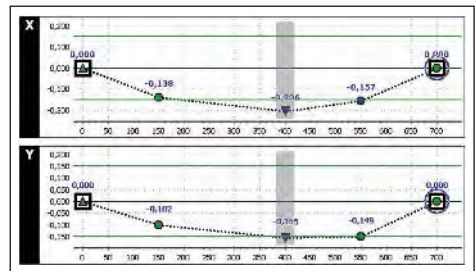

3.1 Choosing a coordinate system

By simply pressing the appropriate icon, it is possible to choose a coordinate system most fitting to the layout of your machine.



4. Measurement procedure

4.1. Setup and measurement



Lasertransmitter T250

Assemble the measurement equipment according to your task or as defined in the appropriate manual "SP Borealign Kit" (BA_BorealignKit_1035_E). Connect the power supply to the laser.

4.2 LED on the R545

Green:	Receiver is switched on
Green blinks slowly:	Operating time < 1h
Green blinks fast (5hz):	Prepare to charge receiver
Red constant:	Charging
Red blinking:	Charging completed
Blue LED:	Connected via Bluetooth

4.3 Charging of the R545

After connecting the R545 to the power supply the charging process starts automatically (red LED is on). When the red LED starts blinking the charging is completed. The charging time depends on the current battery status of the R545 and takes a maximum time of 8 hours. After charging for 3 hours the capacity is approx. 80%.

It is not possible to charge the sensor and measure at the same time.

4.4 Programme outlay

To start the measurement procedure, press the following symbol



Now the "measure" screen opens and asks for the distance. Normally you start here with a "0". Furthermore you can choose whether you would like to enter an absolute or an incremental value.

Start the measurement now by clicking the symbol



You will see a blue circle rotating during the measurement. Do not touch the receiver during this time!

According to the measurement method chosen, you now have to move the sensor to the next point in the measurement. After all required points have been completed the symbol "OK" will be visible. By pressing OK the measurement is stored.

Measure the next bores in the same way.

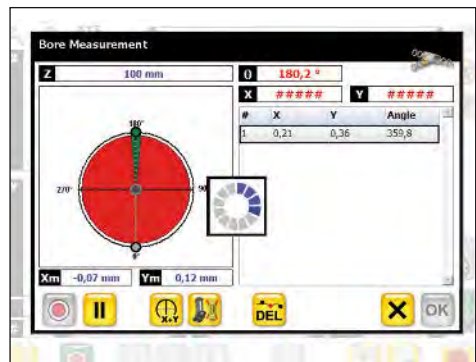
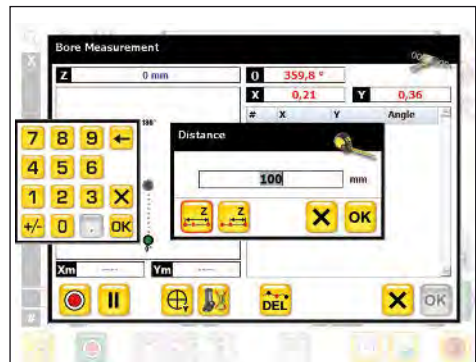
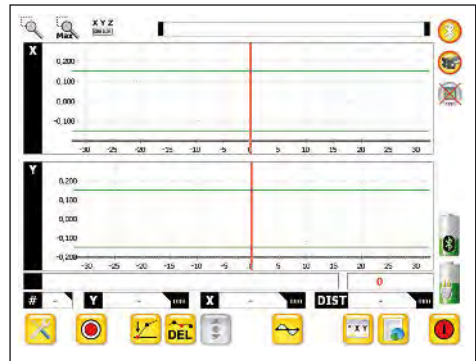

4.5 The measurement screen

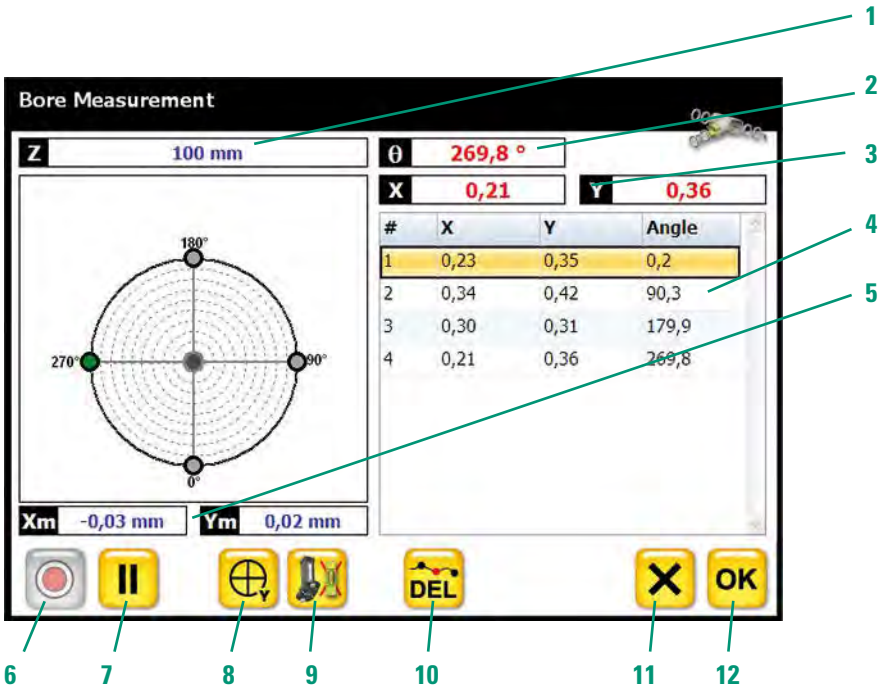

1. Distance of the bore from the origin
2. Angle of the receiver
3. Numeric value of the raw data
4. Numeric value of all measured data
5. Numeric value of the calculated centre of the circle
6. "Start measurement"
7. Pause
8. Choose the Method of measurement
9. Manual input of the angle
10. Delete a value
11. Cancel the measurement
12. Measurement completed / store results

4.6 Measurement methods

You can choose the measurement method in the following window:

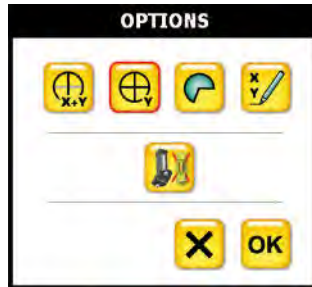

4.6.1 The two point measurement



Here, two points at opposite positions within the circle are measured in X and Y. The measurement is based on a distance measurement of the receiver to the beam. By using the so called “Umschlagmessung” both values for X and Y are measured in two opposite positions and the result is stored.

With a simple calculation $((a + b)/2)$ the centre of the circle is calculated.

The angle detection works automatically, so even if a 180° position is not reached the system calculates the values through interpolation.

Centre of the circle as reference

1. Measurement $M1 = 0,00$

Turn the “receiver” (here, the ruler) through 180°

2. Measurement $M2 = 2,00$

Distance (D) from the centre of the bore to the laser beam

$$D = \frac{M2 - M1}{2}$$

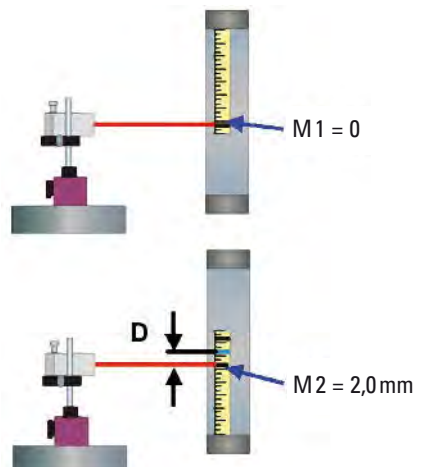

Measurement of a1–a4 und b1–b4

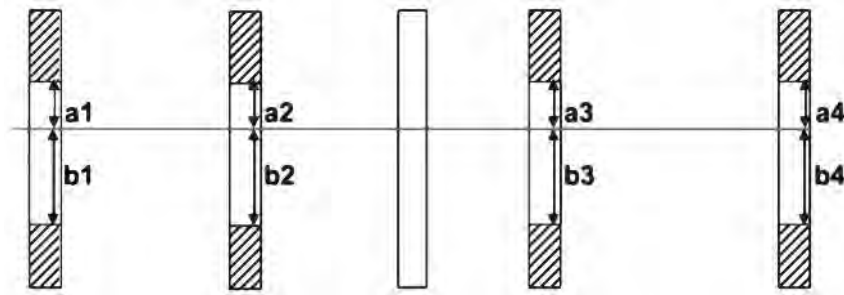

When the bores are in line and the laser beam is not in the centre
is: $a1 = a2 = a3 = a4$ und $b1 = b2 = b3 = b4$

4.6.2 The "4-Point" Measurement



The setup and the measurement of the 4-point method is the same as with the 2-point measurement. The difference is: only the Y value is needed for the calculation. So we need to measure at four points to receive the coordinates for X and Y. The measurements are performed at 0° , 90° , 180° and 270° .

This method could be helpful for large diameters ($>1\text{m}$). The calculation is the same as for the 2-point method.

4.6.3 The Multipoint Measurement



By using the multipoint measurement the angle, X and Y are measured. The measurements can be performed at any angle.

By knowing at least three coordinates in a coordinate system it is possible to calculate a corresponding circle through those points. To receive the best results the angle between the measurements should be as large as possible.

Free measurement of points

The main advantage of this method is the possibility to measure many points. All measured points have an influence on the centre of the circle. So the more points that are measured, the better the result will be.

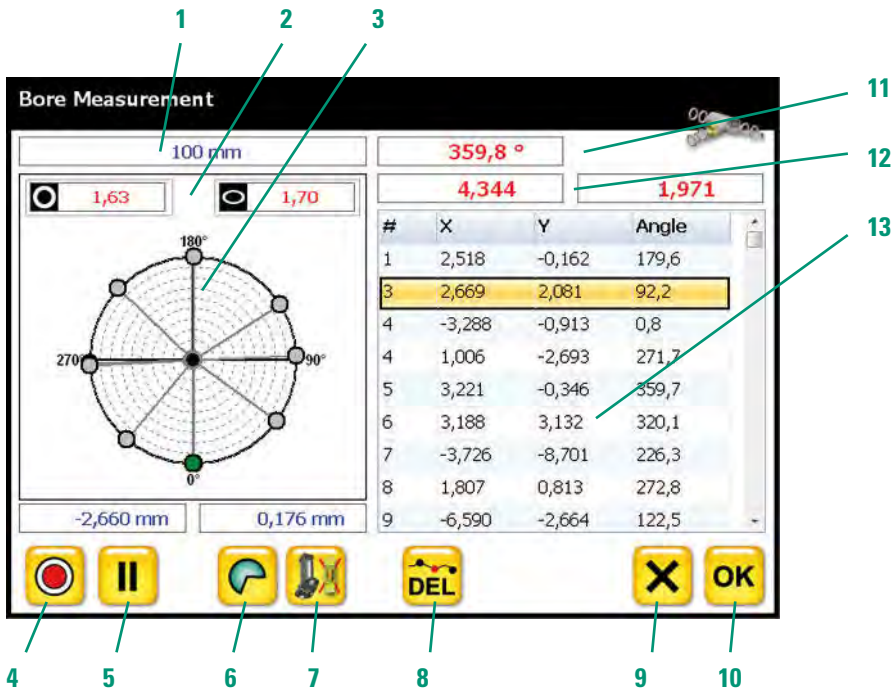

1. Distance for the current measurement from the origin
2. Selection for a circle or ellipse based calculation
3. Display of the measurements in the bore
4. Start measurement
5. Pause
6. Selection of the measurement method
7. Manual input of the angle
8. Delete selected measurement
9. Cancel the whole measurement (at this point)
10. Store measurement and leave the screen
11. Present angle of the detector
12. Present coordinates of the receiver to the laser beam
13. List of the measured data

4.7 Analysis

Directly after you have measured a bore, it will be shown in the Graphic.

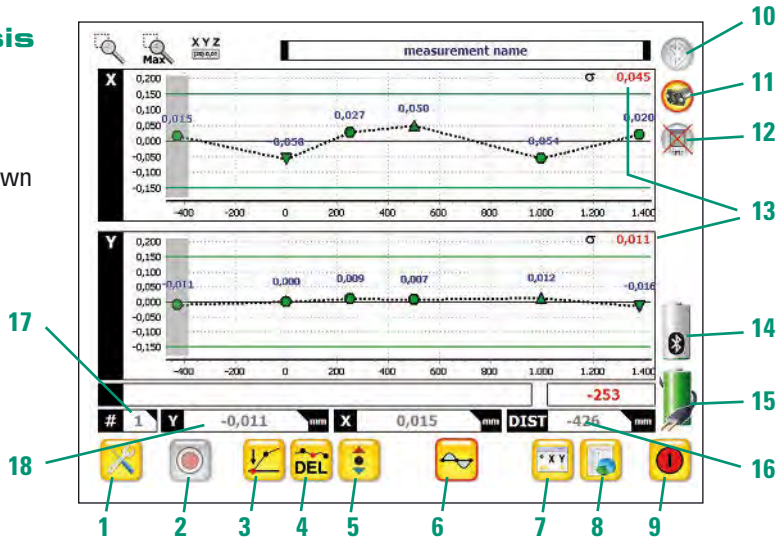

- Menu/set-up button
- Measurement button
- Set the selected point to zero
- Delete the selected point
- Move the selected bore online (e.g. stern tubes)
- Select "Best Fit". When the "Best fit" is selected, a red box will appear around the icon
- Show monitor measurement
- Raw data
- Exit the program
- Symbol "yellow" = Bluetooth is available with the PC, Symbol "grey" = No Bluetooth available
- Symbol "yellow" = Sensor is connected, Symbol "grey" = Sensor is not connected
- Symbol "yellow" = Disto is connected, Symbol "grey" = Disto is not connected
- Standard deviation of the axis
- Battery life of the sensor
- Battery life of the PC
- Display of the distance in which the next measurement will be performed (red values) The grey values are the selected value by clicking on the screen (grey bar)
- The grey value show the number of the selected value (click on the value and a bar will appear)
- Data of a selected measurement

There are three possibilities to display and calculate the measured values:

4.7.1 Zero points

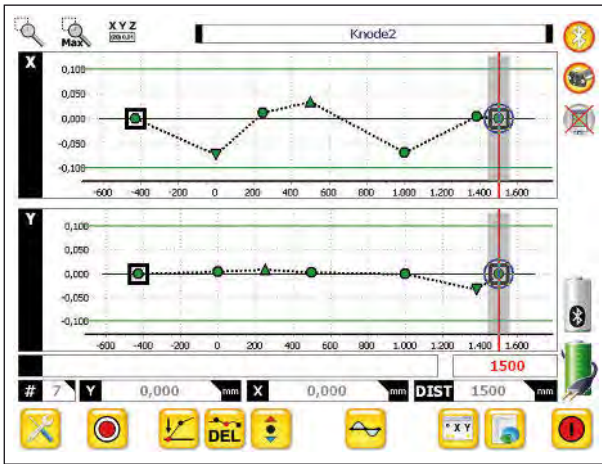

Select two points and set them to zero. In most cases you will select the first and the last point as "Zero points". Just select the point using your finger tip, then press the  symbol.

4.7.2. Raw data

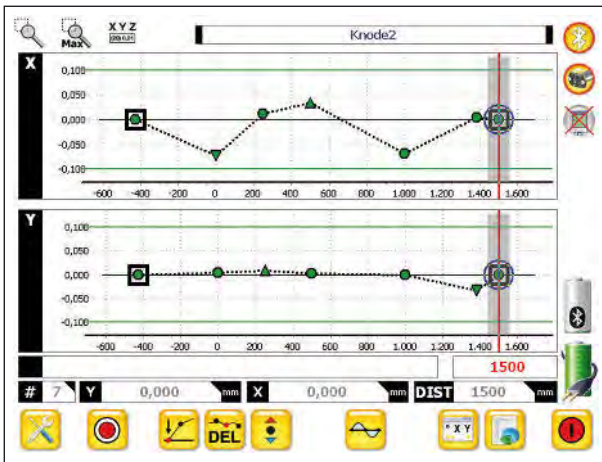

For some measurements you will need to have a look at the raw data. For example, if the laser has to be aligned in the middle of an axis and you need a direct view of the raw data. Just touch the symbol for the "Zero" again on the selected point and the software will show you the raw data.

If the laser was aligned to represent a rotational axis, the data will give you direct information of the alignment of the bore in relation to the axis (eg. Engine to the stern tube).

4.7.3 "Best fit" Line

A helpful tool is the so called "Best Fit" line. Here all deviations are calculated and the program generates a line through all points to minimize the deviation.



Touch the symbol and the program generates the "Best Fit" line.

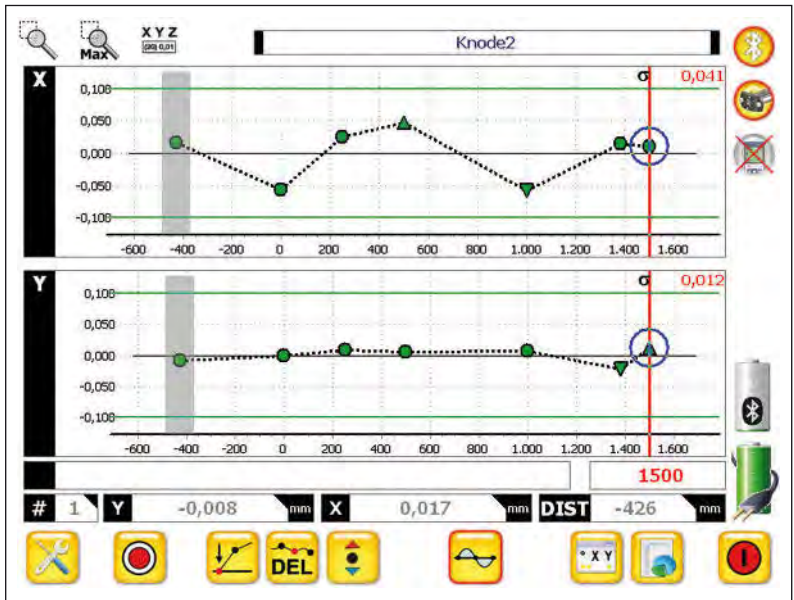

5. The raw data screen



Touch the  symbol and the program gives you an overview of all measured values and the raw data. All data are corresponding to the chosen method of the measurement. So if the "Best Fit" is selected the data will show the deviation from the "Best Fit" Line.

Name		Knode2		Date	2010-12-13		Time	15:03:03		
Nr	Dist [mm]	Delta	Y [mm]	X [mm]	Angle°	Name	Temp			
1	-426,000	0,000	-0,008	0,017			20,1			
			1,039	1,225	180,0					
			1,028	1,202	0,0					
2	0,000	426,000	0,000	-0,057			20,1			
			0,998	1,213	180,0					
			1,000	1,055	0,0					
3	250,000	250,000	0,008	0,026			20,1			
			0,986	1,222	-0,7					
			0,972	1,204	180,0					
4	500,000	250,000	0,005	0,048			20,1			
			1,004	1,331	0,0					
			0,999	1,260	180,0					
Y [mm]	σ	0,012	∅	0,000	Δ	0,012	∇	-0,023	↑↓	0,035
X [mm]	σ	0,041	∅	0,000	Δ	0,048	∇	-0,058	↑↓	0,106

1. Store the measurement
2. Export the data as a *.csv file. You can open the data with a Program such as MS Excel. Furthermore a USB stick is recognized automatically and the program allows a direct export of the values and Graphics to the stick
3. Scroll the screen up or down
4. Back to the graphical overview

6. The initial setup screen

In the setup you can choose the units, measurement times, and so on:

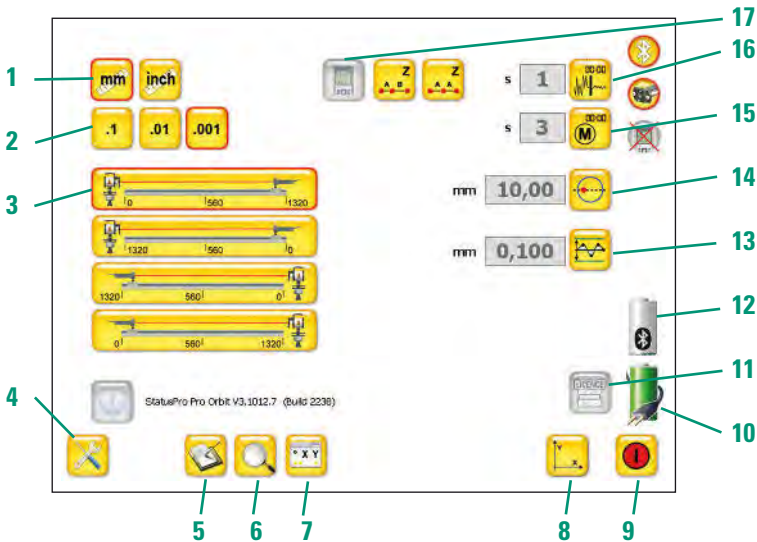

1. Choose the units of measurement
2. Choose the measurement resolution
3. Choose your laser setup
4. Setup/Menu
5. Log file (protocol of the BTconnection status)
6. Search for new receivers
7. Raw data of the Receiver PSD (helps to setup the system)
8. Back to the graphical overview
9. Exit the program
10. Battery status of the UMPC
11. License: here you can enter the license of the connected receiver
12. Battery status of the receiver
13. Tolerances (display of two parallel lines in the graphic screen)
14. "Automatic catch" for overwriting measurements after adjusting*
15. Measurement time (Average)
16. Display average (Averaging of the displayed live value)
17. Choose if the distances between measurement points are equal (A-A) or different (A-B)

* Automatic catch:

The value can be set to define how close the sensor has to be to the previous measured point when adjusting and overwriting, (Disto needed)

6.1 Setup bar

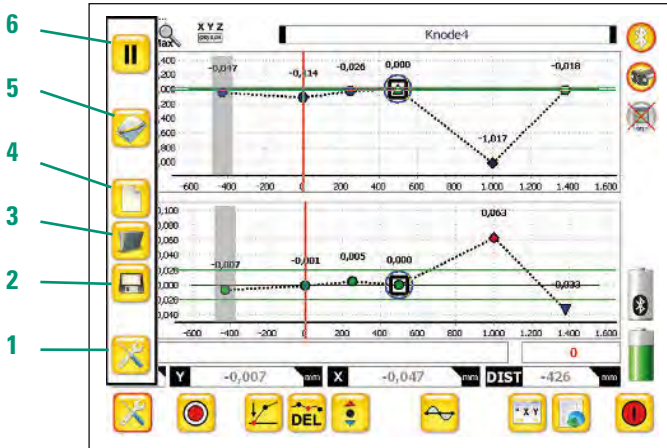

1. Menu / Setup icon
2. Save a measurement
3. Open an previously recorded measurement
4. Start a new measurement
5. Re-name a measurement
6. Pause button (no real-time values will be displayed)

6.2 Save to memory / measurement name

When the store to memory or Re-name button is pressed the following digital keyboard will appear:



6.3 Open an existing measurement

Choose the desired measurement text, then confirm by pressing the icon:



To delete a measurement, choose the measurement text, then press the icon:



To close the current window press the button:

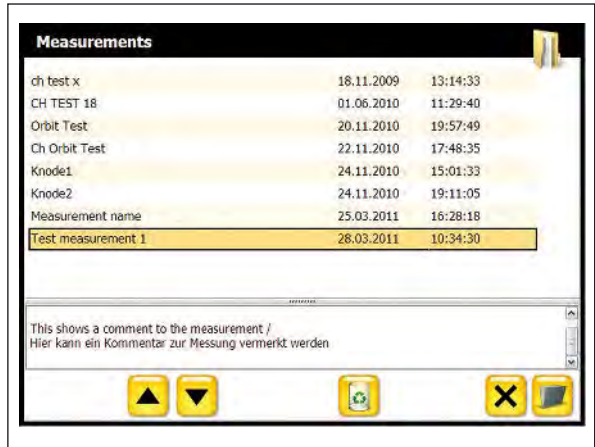

7. New sensors / license key

When you purchase a complete package including UMPC from Status Pro, all license keys have been entered and the system is ready to go. If however you prefer to use your own PC or if you purchase a receiver or a license key at a later date, the receiver has to be registered with the software. Together with the software you will receive the license for your receiver.

By starting ProOrbit the new receiver will be detected automatically and you will be prompted to enter the License key.

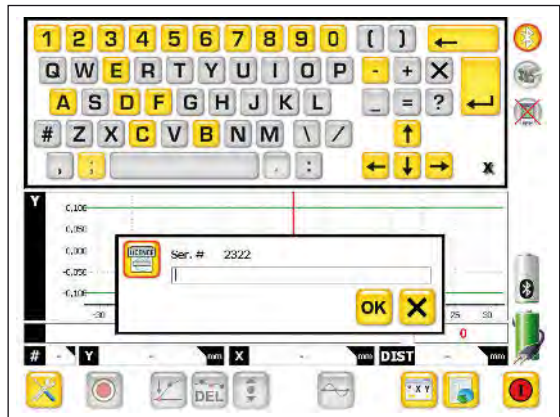



Status Pro Maschinenmesstechnik GmbH
Mausegatt 19
D-44866 Bochum
Phone: + 49 (0) 2327 - 9881 - 0
Fax: + 49 (0) 2327 - 9881 - 81
www.statuspro.com
info@statuspro.com

Distributor